

Focus Model Focus 60

Focus is a multifunctional projector inspired by the world of photography, both in its lines and design, with details that evoke analogue cameras – from the graduated scale engraved on the body, reminiscent of focal lengths, to the front ring that echoes the historic models of Leica and Pentax.

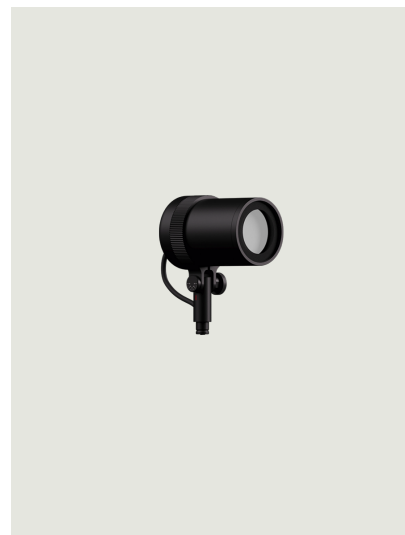

Focus 60

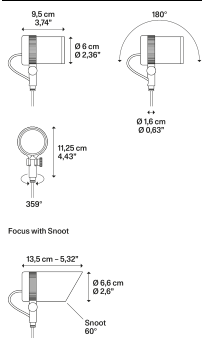

Light source

24V
LED 13,4 W
CRI ? 90
MacAdam < 3–Step

Cable lenght 1,5 m
Rubber cable
Section 2x 0,5 mm2

or

Built-in driver
LED 13,4 W
CRI ? 90
MacAdam < 3–Step

Cable lenght 1,5 m
Rubber cable
Section 3x 1 mm2

Structure

	Code 2700 K	Code 3000 K
● Matte Black – 9005	800042022	800042027
● Matte Black – 9005	800052022	800052027
● Matte Anthracite	800044422	800044427
● Matte Anthracite	800054422	800054427
● Matte Champagne	800044522	800044527
● Matte Champagne	800054522	800054527
● Natural Brown	800046922	800046927
● Natural Brown	800056922	800056927
● Generazione scheda tecnica	800047022	800047027
● Generazione scheda tecnica	800057022	800057027

Net weight: 0.85 kg

Parcels: 1

CE

E

EMC

PWM

24V

III

TRIAC

220–240V

⊥

Energy efficiency class



Options of Focus

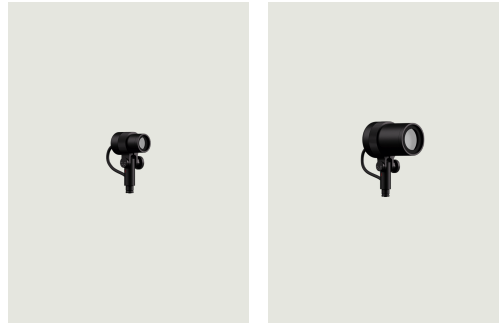

Focus 28

Focus 48

LODES OUTDOOR

Focus 28

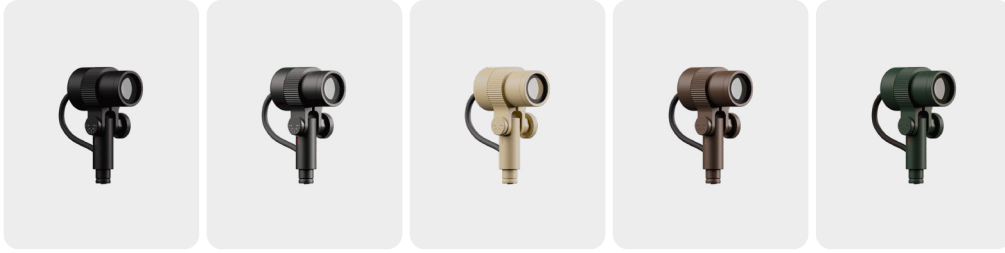

Focus 48

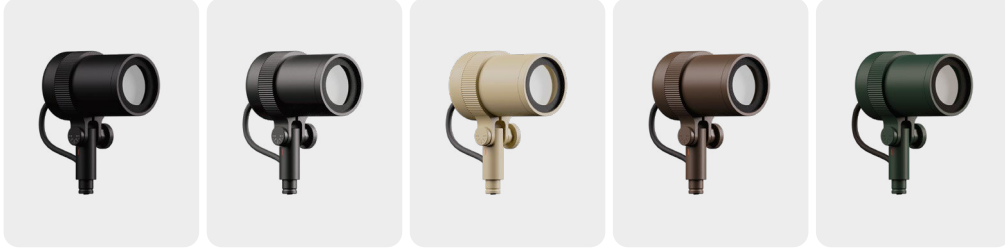

Focus 60

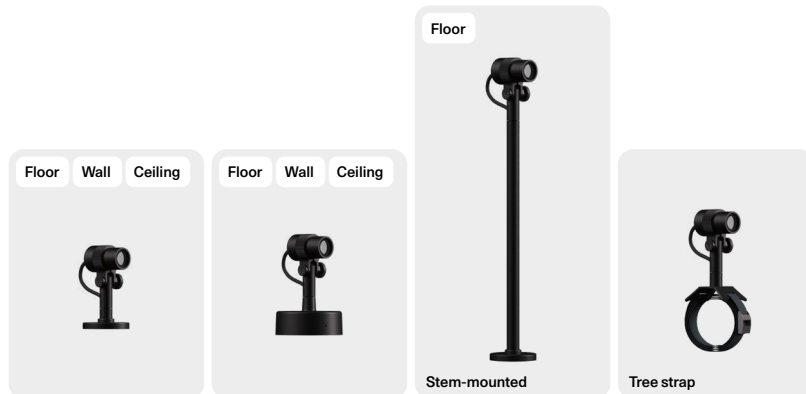

LODES OUTDOOR

Focus 28



Dimensions Dimensioni

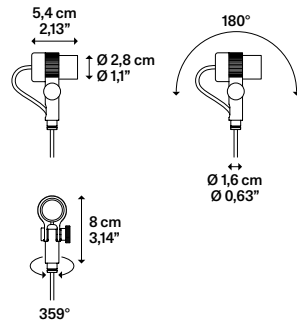

Category Categoria

Multifunctional Projector

Year	2025	
Designer	Patrick Norguet	
Voltage Voltaggio	24 V	
	IP67	IK08
Net weight Peso netto	0,20 kg 0,44 lbs	Pack Colli 1
Energy class Classe energetica	F	

Light source Sorgente luminosa

80001

24V

LED
2,7 WCRI ≥ 90
MacAdam < 3-Step

Cable length 1,5 m

Rubber cable
Section 2× 0,5 mm²

Remote driver required
(NOT INCLUDED).
Driver remoto necessario
(NON INCLUSO).

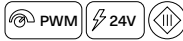

Finish Finitura

20

Matte Black
Nero Opaco

44

Matte Anthracite
Antracite Opaco

45

Matte Champagne
Champagne Opaco

69

Natural Brown
Testa di Moro

70

Natural Green
Verde Natura

Colour temperature Temperatura colore

22

2200 K

310 lm Nominal Flux
170 lm Delivered Flux

27

2700 K

280 lm Nominal Flux
182 lm Delivered Flux

30

3000 K

310 lm Nominal Flux
200 lm Delivered Flux

Optic Optica

SP

16°

Spot

ME

25°

Medium

EW

55°

Extra Wide

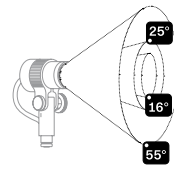

Internal accessory Accessorio interno

H



Honeycomb

G

Half-moon
glare shield

X

No accessories

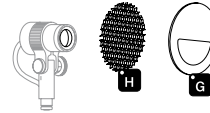

External accessory Accessorio esterno

S



Snoot

X

No accessories

Focus with Snoot

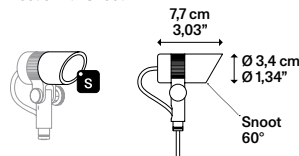

LODES OUTDOOR

Focus 48



Dimensions Dimensioni

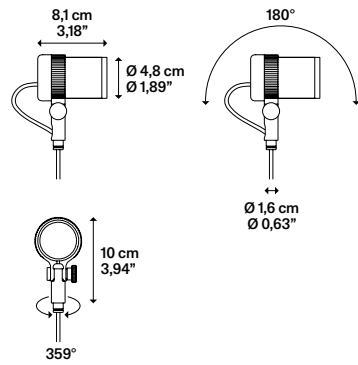

Category Categoria

Multifunctional Projector

Year	2025	
Designer	Patrick Norguet	
Voltage Voltaggio	24 V 220-240 V	
	IP67	IK07
Net weight Peso netto	0,55 kg 1,21 lbs	Pack Colli 1
Energy class Classe energetica	F E	2200 K 2700, 3000 K

Light source Sorgente luminosa

80002 *

24V

 LED
6,1 W CRI ≥ 90
MacAdam < 3-Step

80003

BUILT-IN DRIVER

 LED
6,1 W CRI ≥ 90
MacAdam < 3-Step

 Cable length 1,5 m Rubber cable
Section 2× 0,5 mm²

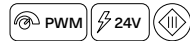
 Cable length 1,5 m Rubber cable
Section 3× 1 mm²

* Remote driver required
(NOT INCLUDED).
Driver remoto necessario
(NON INCLUSO).

Finish Finitura

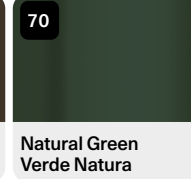
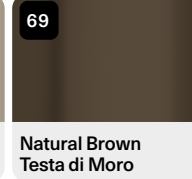
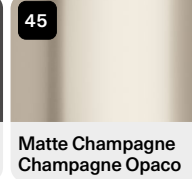
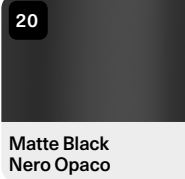

Colour temperature Temperatura colore

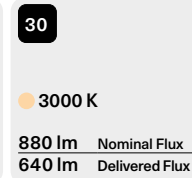
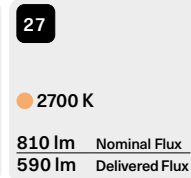
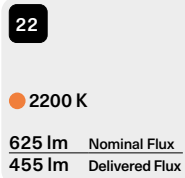

Optic Optica

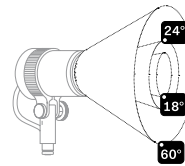
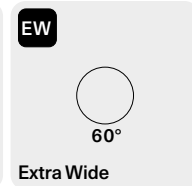
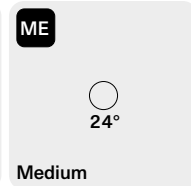
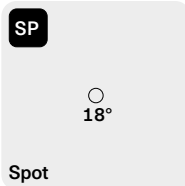

Internal accessory Accessorio interno

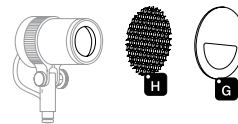
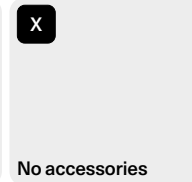
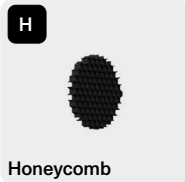

External accessory Accessorio esterno

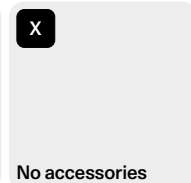
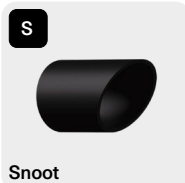

Focus with Snoot

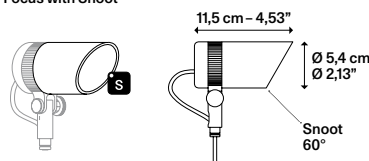

LODES OUTDOOR

Focus 60



Dimensions Dimensioni

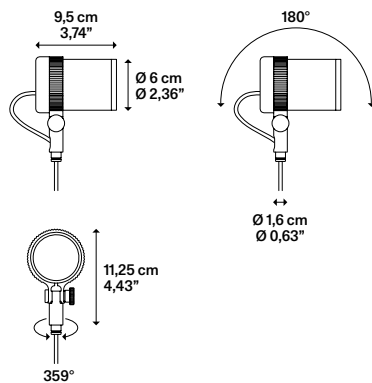

Category Categoria

Multifunctional Projector

Year	2025	
Designer	Patrick Norguet	
Voltage Voltaggio	24 V 220-240 V	
IP67		IK07
Net weight Peso netto	0,85 kg 1,87 lbs	Pack Colli 1
Energy class Classe energetica	F E	2200 K 2700, 3000 K

Light source Sorgente luminosa

80004 *

24V

 LED
13,4 W CRI ≥ 90
MacAdam < 3-Step

80005

BUILT-IN DRIVER

 LED
13,4 W CRI ≥ 90
MacAdam < 3-Step

 Cable length 1,5 m Rubber cable
Section 2× 0,5 mm²

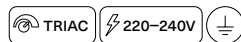
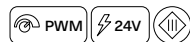
 Cable length 1,5 m Rubber cable
Section 3× 1 mm²

* Remote driver required
(NOT INCLUDED).
Driver remoto necessario
(NON INCLUSO).

Finish Finitura

20

 Matte Black
Nero Opaco

44

 Matte Anthracite
Antracite Opaco

45

 Matte Champagne
Champagne Opaco

69

 Natural Brown
Testa di Moro

70

 Natural Green
Verde Natura

Colour temperature Temperatura colore

22

2200 K

 1110 lm Nominal Flux
890 lm Delivered Flux

27

2700 K

 1440 lm Nominal Flux
1155 lm Delivered Flux

30

3000 K

 1520 lm Nominal Flux
1220 lm Delivered Flux

Optic Optica

SP

18°

Spot

ME

24°

Medium

EW

60°

Extra Wide

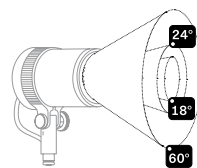

Internal accessory Accessorio interno

H



Honeycomb

G

 Half-moon
glare shield

X

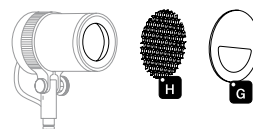
No accessories



External accessory Accessorio esterno

S

Snoot

X

No accessories

Focus with Snoot

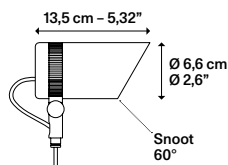
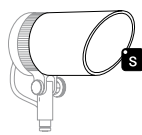

Mounting accessories Accessori di installazione

80099



Fixing base Base di fissaggio

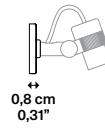
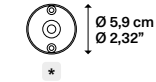
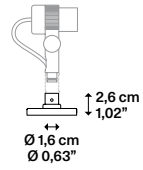

Surface mounting base.
Base di montaggio a superficie.

*

Cover accessory for fixing base available, to be ordered separately. ► P. 006

Accessorio di copertura per base di fissaggio disponibile, da ordinare separatamente. ► P. 006

Finishes Finiture

20 Matte Black
44 Matte Anthracite
45 Matte Champagne
69 Natural Brown
70 Natural Green

Nero Opaco
Antracite Opaco
Champagne Opaco
Testa di Moro
Verde Natura

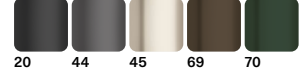

Net weight Peso netto	0,10 kg 0,22 lbs	Pack Colli	1
--------------------------	---------------------	---------------	---

80098



Connection base Base per connessioni interne

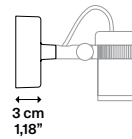
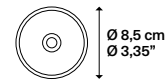
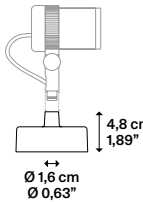

Surface mounting base with space for internal connections.
Base di montaggio a superficie con spazio per connessioni interne.

Finishes Finiture

20 Matte Black
44 Matte Anthracite
45 Matte Champagne
69 Natural Brown
70 Natural Green

Nero Opaco
Antracite Opaco
Champagne Opaco
Testa di Moro
Verde Natura

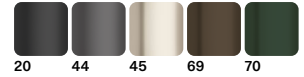

Net weight Peso netto	0,20 kg 0,44 lbs	Pack Colli	1
--------------------------	---------------------	---------------	---

80097

80096

80095

Stem with fixing base for surface installation Stelo con base di fissaggio per installazione a superficie

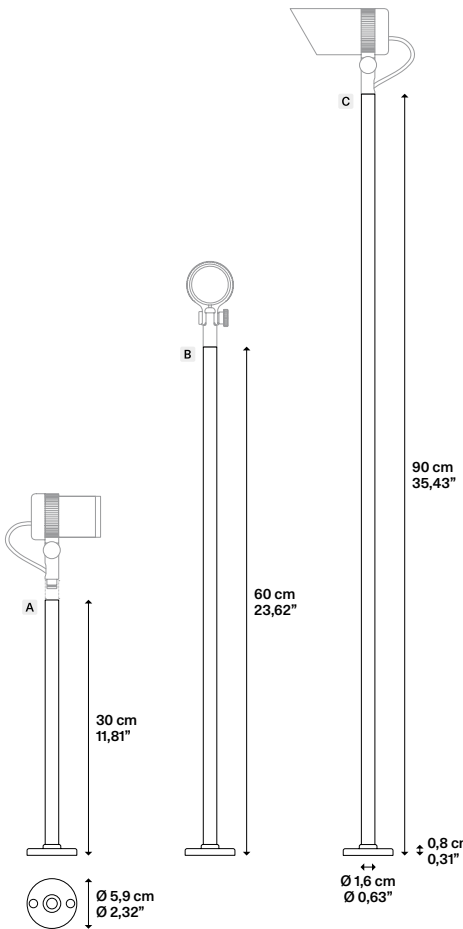

*

Cover accessory for fixing base available, to be ordered separately. ► P. 006

Accessorio di copertura per base di fissaggio disponibile, da ordinare separatamente. ► P. 006

Finishes Finiture

20 Matte Black
44 Matte Anthracite
45 Matte Champagne
69 Natural Brown
70 Natural Green

Nero Opaco
Antracite Opaco
Champagne Opaco
Testa di Moro
Verde Natura

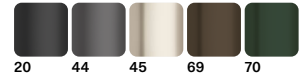

Net weight Peso netto	A	0,15 kg 0,33 lbs	Pack Colli	1
	B	0,20 kg 0,44 lbs		
	C	0,30 kg 0,66 lbs		

Mounting accessories
Accessori di installazione

80090



Fixing tree strap (max length 5 m - 196,85")
Cinghia di fissaggio per albero (lunghezza max 5 m - 196,85")

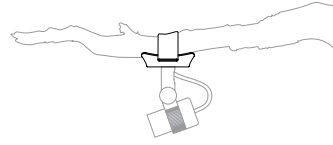
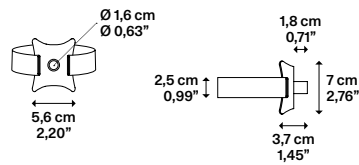

Finish
Finitura

20 Matte Black Nero Opaco



20

Net weight Peso netto	0,20 kg 0,44 lbs	Pack Colli	1
--------------------------	---------------------	---------------	---

80089



Spike for direct ground installation
Picchetto per installazione nel terreno

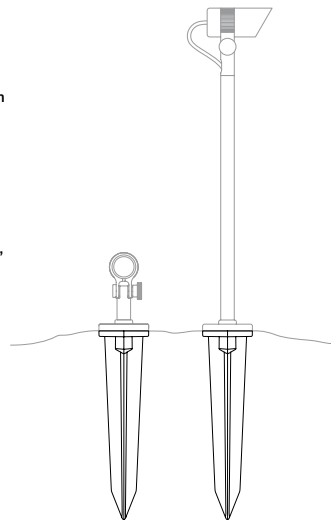
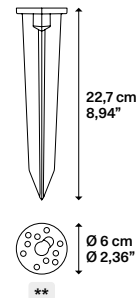

**

The ground spike can be added only to the base (code 80099) or to the three stem heights (codes 80097, 80096, 80095).

Il picchetto può essere aggiunto solo alla base (cod. 80099) o alle 3 altezze di stelo (cod. 80097, 80096, 80095).

Finish
Finitura

20 Matte Black Nero Opaco



20

Net weight Peso netto	0,10 kg 0,22 lbs	Pack Colli	1
--------------------------	---------------------	---------------	---

Accessory
Accessorio

80088

Cover for fixing base
Copertura per base di fissaggio

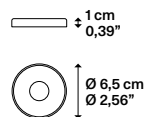

Finishes
Finiture

20 Matte Black Nero Opaco
44 Matte Anthracite Antracite Opaco
45 Matte Champagne Champagne Opaco
69 Natural Brown Testa di Moro
70 Natural Green Verde Natura

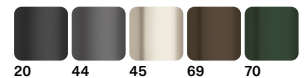

20

44

45

69

70

Net weight Peso netto	0,02 kg 0,04 lbs	Pack Colli	1
--------------------------	---------------------	---------------	---

Focus

Product code configuration guide
Guida alla configurazione del codice prodotto

Select the available options to configure the product code correctly. ■ EN Seleziona le opzioni disponibili per configurare correttamente il codice del prodotto. ■ IT

Product Prodotto

Focus 28 80001

24 V

Remote driver required (NOT INCLUDED). / Driver remoto necessario (NON INCLUSO).

Focus 48 80002

24 V

Remote driver required (NOT INCLUDED). / Driver remoto necessario (NON INCLUSO).

OR

80003

220-240 V

Built-in driver. / Driver integrato.

Focus 60 80004

24 V

Remote driver required (NOT INCLUDED). / Driver remoto necessario (NON INCLUSO).

OR

80005

220-240 V

Built-in driver. / Driver integrato.

Finish Finitura

20

Matte Black
Nero Opaco

44

Matte Anthracite
Antracite Opaco

45

Matte Champagne
Champagne Opaco

69

Natural Brown
Testa di Moro

70

Natural Green
Verde Natura

Colour temp Temp. colore

22

● 2200 K
CRI ≥ 90
MacAdam
< 3-Step

27

● 2700 K
CRI ≥ 90
MacAdam
< 3-Step

30

● 3000 K
CRI ≥ 90
MacAdam
< 3-Step

Optic Ottica

SP

Spot

ME

Medium

EW

Extra Wide

Int. accessory Acc. interno

H

Honey-comb

G

Half-moon glare shield

X

No acc.

Ext. accessory Acc. esterno

S

Snoot

X

No acc.

Mounting accessories Accessori di installazione

Mounting Installazione

80099

Fixing base
Base di fissaggio

80098

Connection base
Base per connessioni

80097

30 cm
11,81"

Stem with base
Stelo con base

80096

60 cm
23,62"

Stem with base
Stelo con base

80095

90 cm
35,43"

Stem with base
Stelo con base

80090

Tree strap
Cinghia per albero

Finish Finitura

20

Matte Black
Nero Opaco

44

Matte Anthracite
Antracite Opaco

45

Matte Champagne
Champagne Opaco

69

Natural Brown
Testa di Moro

70

Natural Green
Verde Natura

80089

Spike
Picchetto

The ground spike can be added only to the base (code 80099) or to the three stem heights (codes 80097, 80096, 80095).

20

Matte Black
Nero Opaco

Il picchetto può essere aggiunto solo alla base (cod. 80099) o alle 3 altezze di stelo (cod. 80097, 80096, 80095).

Configuration examples Esempi di configurazione

Focus 28 Floor

80001 70 22 SP H S
80097 70

Focus 48 Wall

80002 69 27 ME X X
80098 69

Focus 60 Floor (GROUND)

80005 20 30 EW X X
80099 20
80089 20